

JUNGLE FORT®

BACKYARD PLAYGROUND BUILDING KITS



COPYRIGHT ©1998-2012 DETAILED PLAY SYSTEMS
ALL RIGHTS RESERVED.

INTRODUCTION

Thank you for downloading our site plans and for your interest in Detailed Play Systems!

Detailed Play Systems products deliver superior backyard playground quality and value. The Jungle Fort Swingset is a Consumer's Digest magazine "Best Buy" award winner in the category of economical backyard playgrounds. Our forts, towers, and swing sets are the most solidly designed Just Add Lumber™ Kit backyard playgrounds available and the features of the finished product are comparable to those found in expensive brand name sets. Adding strength and longevity requires more bolting and hardware in our kits, a worthwhile investment especially when investing the time to build. Build once using our products, Jungle Fort® play structures should not be expected to ever need replacement.

Please call or visit our website to see our complete line of plan compatible kits, swings, slides, hardware, and accessories for any backyard playground available at www.detailedplay.com

Build Memories! Thanks again for your interest in Detailed Play Systems.

Detailed Play Systems

Web: www.detailedplay.com

Telephone: 1-800-398-7565

Email: playsets@detailedplay.com

Facebook: www.facebook.com/DetailedPlay

FREE PLAN BOOK PDF

Free Detailed Plans PDF with Any Kit Purchase! Download complete building plans: www.detailedplay.com/SwingsetPlans.htm

Please share these Site Plans with your friends and family:



[Email](#)



[Facebook](#)



[Twitter](#)



[Stumble](#)



[Digg](#)

Jungle Swingset Slide SITE PLANS

12L x 11-17W

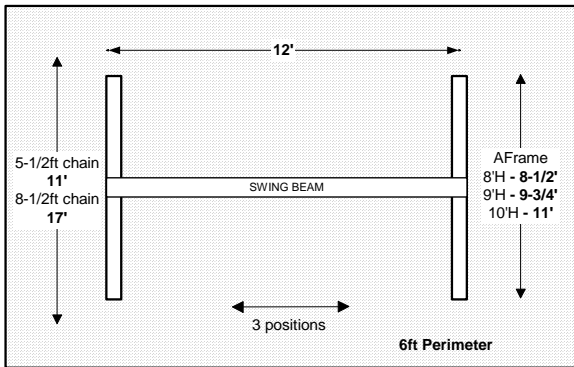

15L x 20W

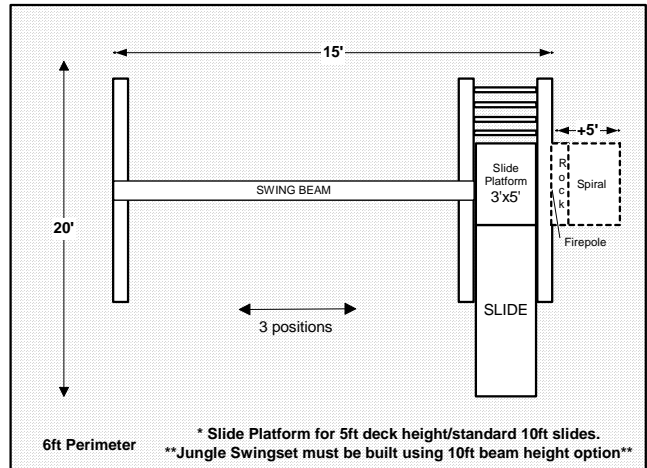

18L x 22W

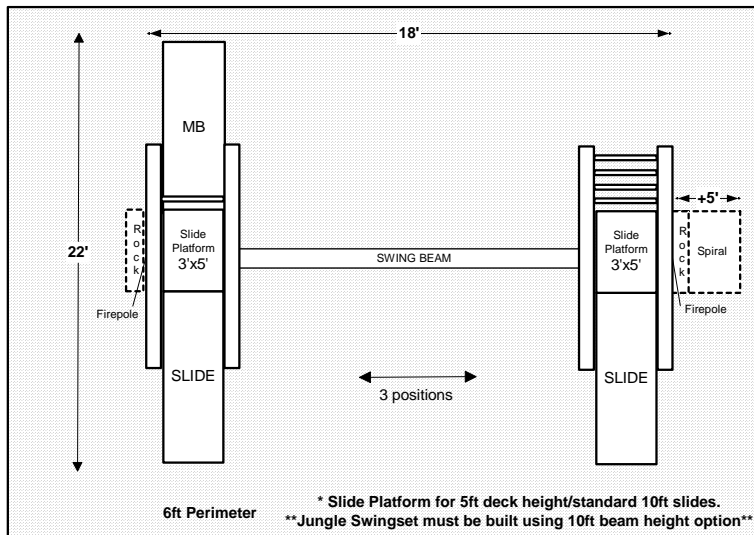

26L x 22W

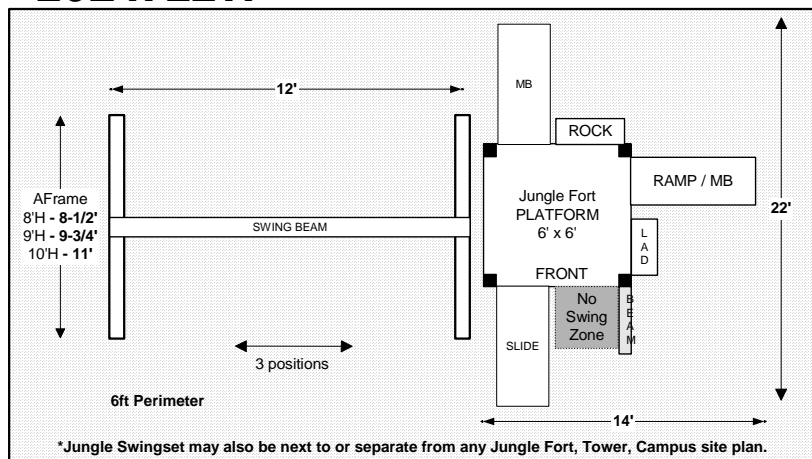

11L x 15W

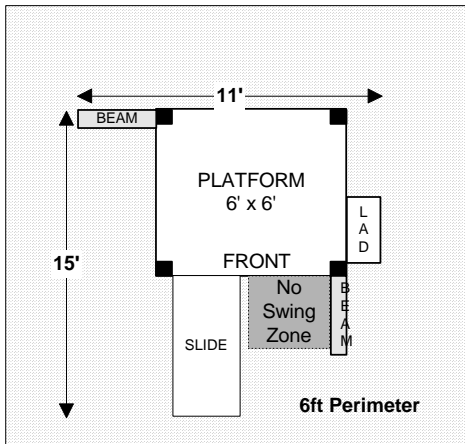

18L x 9W

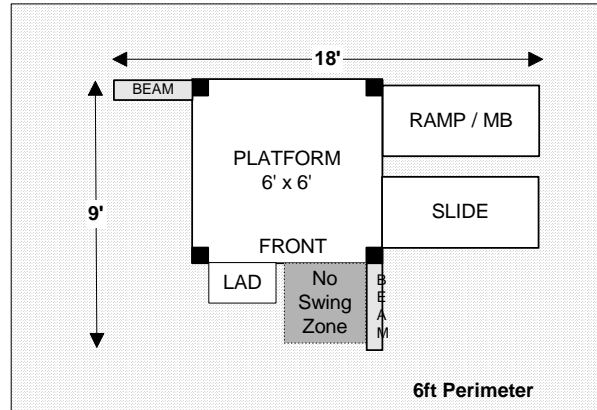

18L x 15W

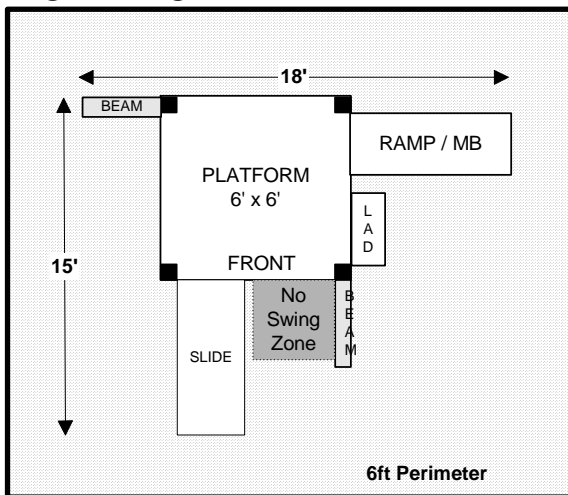

18L x 17W

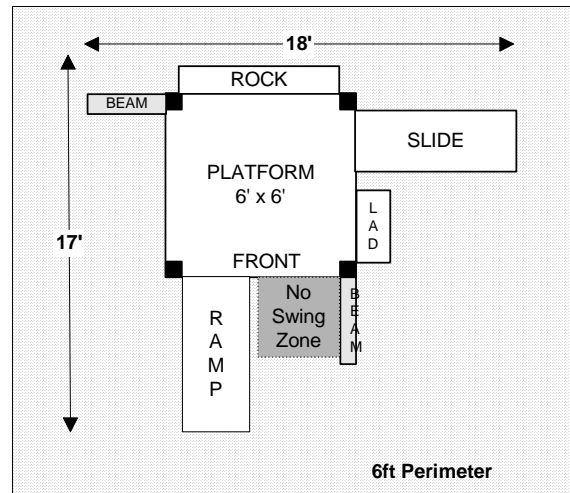

18L x 15W

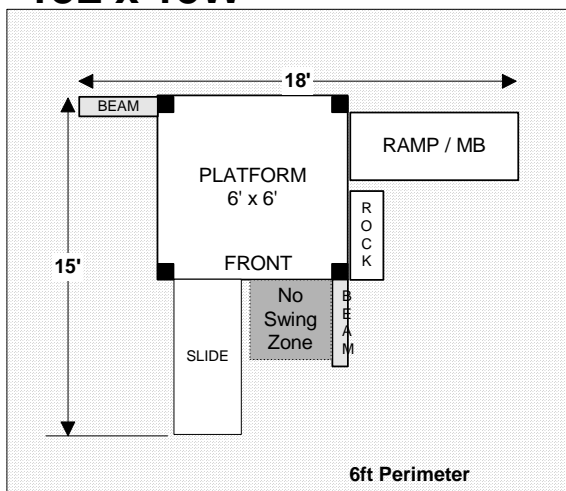

18L x 22W

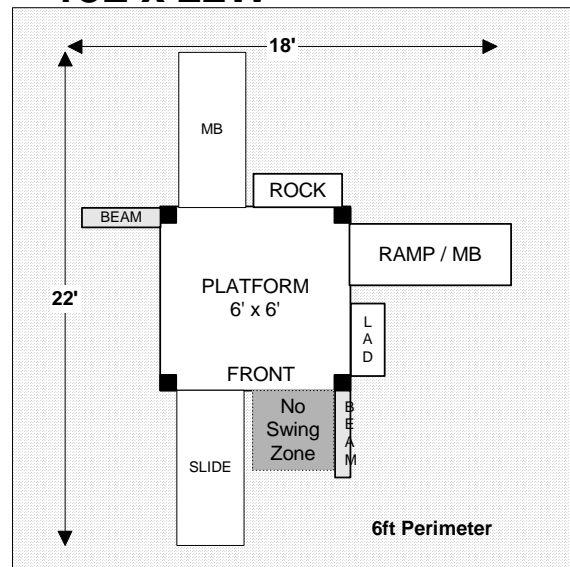

Jungle Fort Swingset
SITE PLANS

16L x 17W

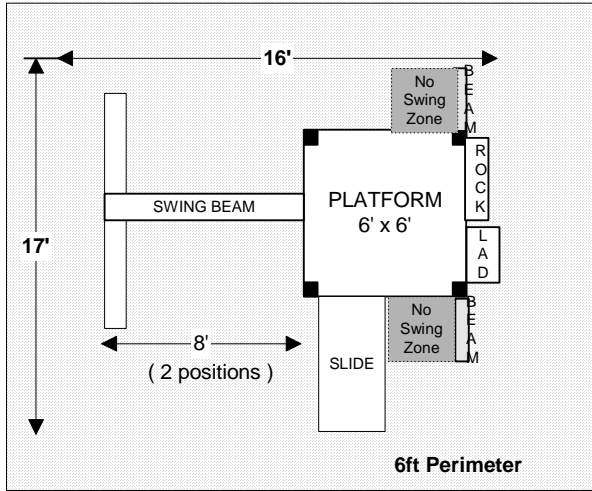

22-30L x 14W

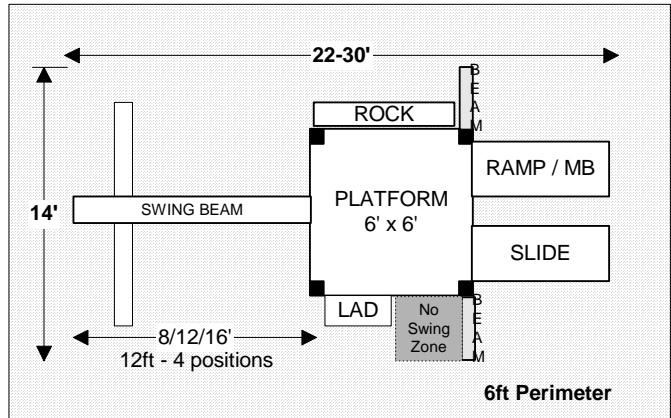

22-30L x 17W

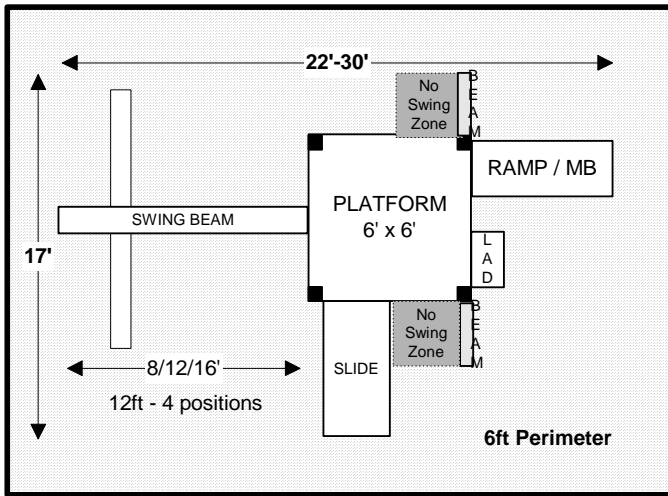

22-30L x 17W

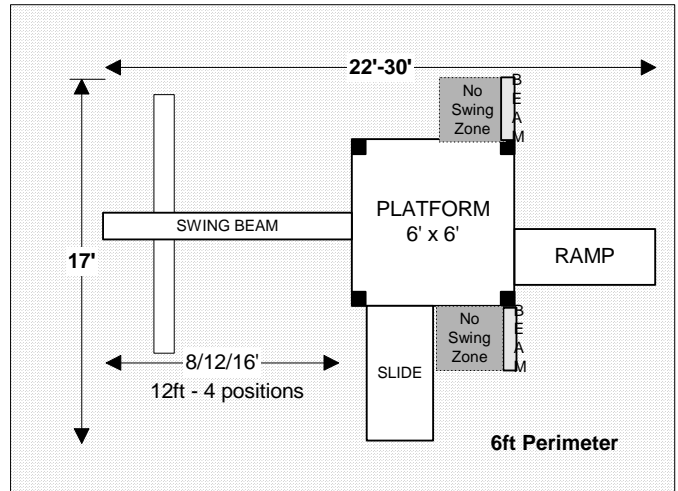

22-30L x 17W

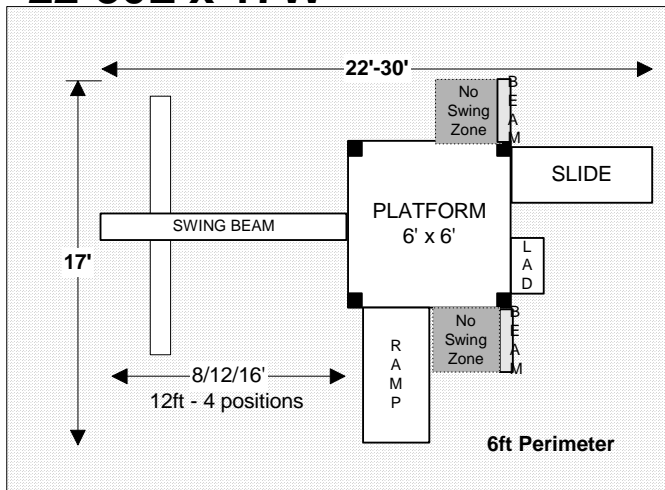

22-30L x 22W

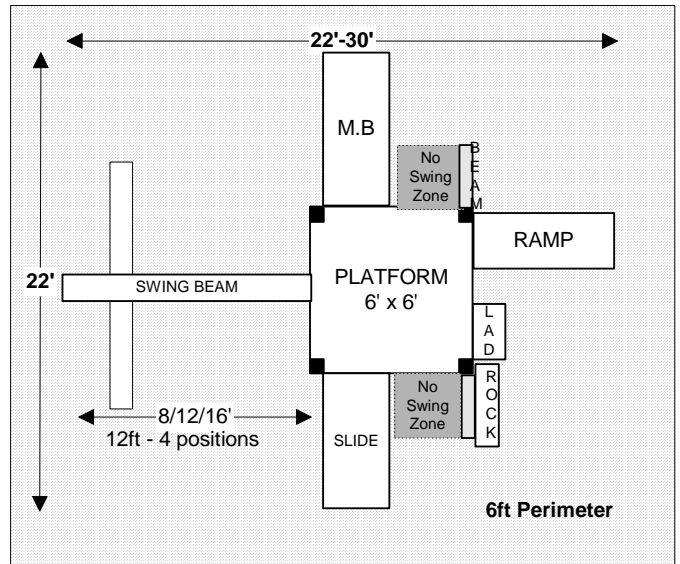

* Swing Beam can be 8ft (2 pos), 12ft (4 pos), 16ft (5 pos) or moved to RIGHT side.

Jungle Fort Tower SITE PLANS

30-35L x 22W

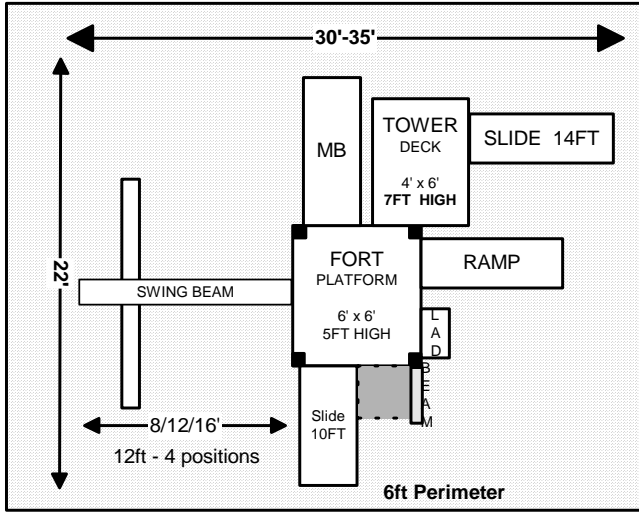

26-30L x 20W

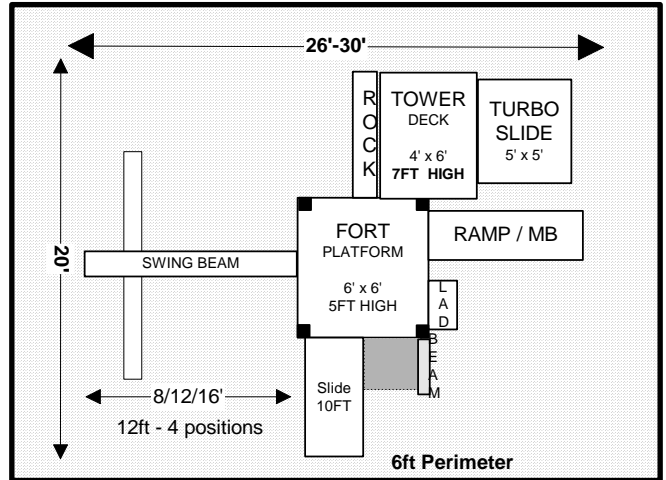

17L x 22W

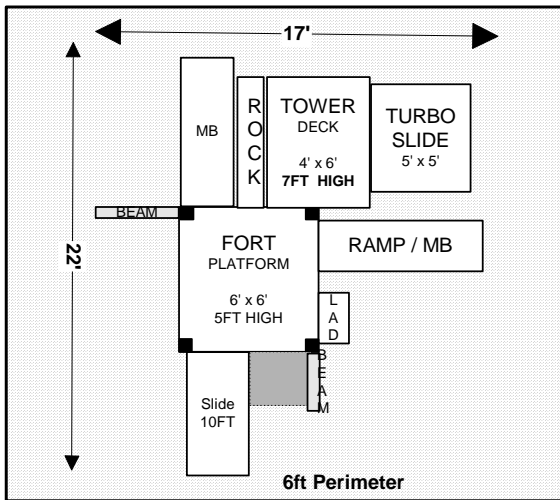

30L x 22W

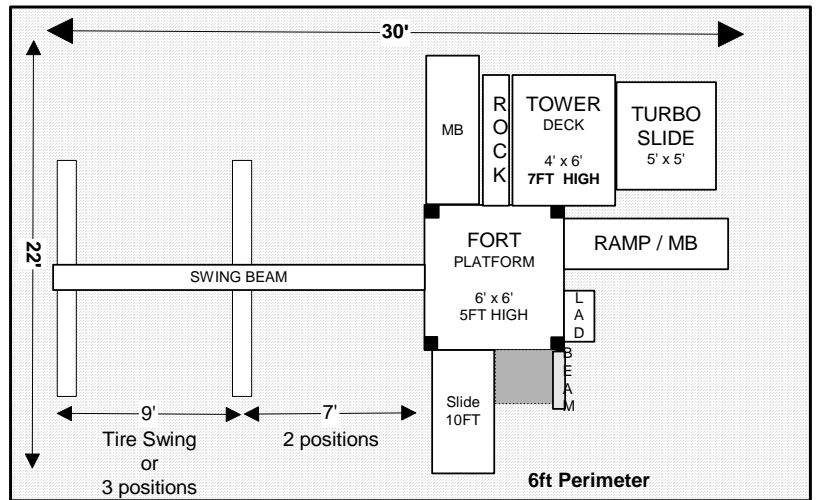

17L x 14W

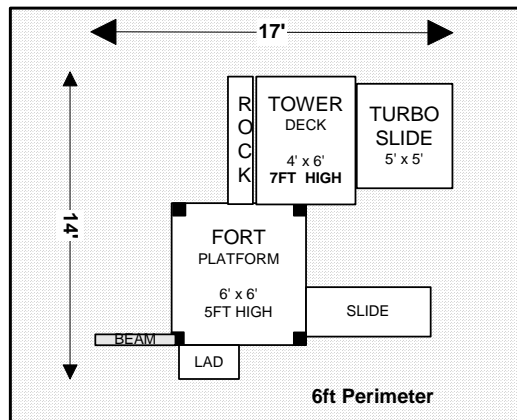

Jungle Fort Campus
SITE PLANS

19L x 16W

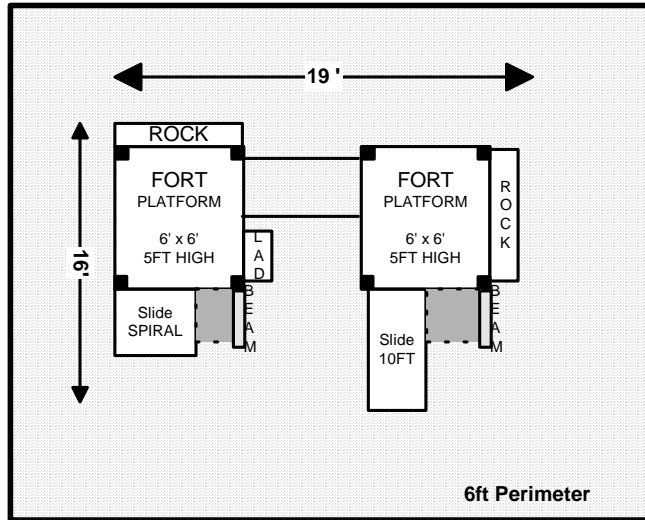

21L x 18W

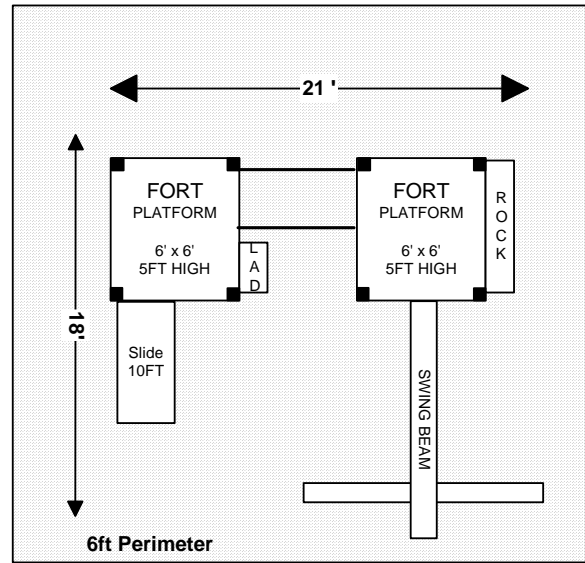

27L x 23W

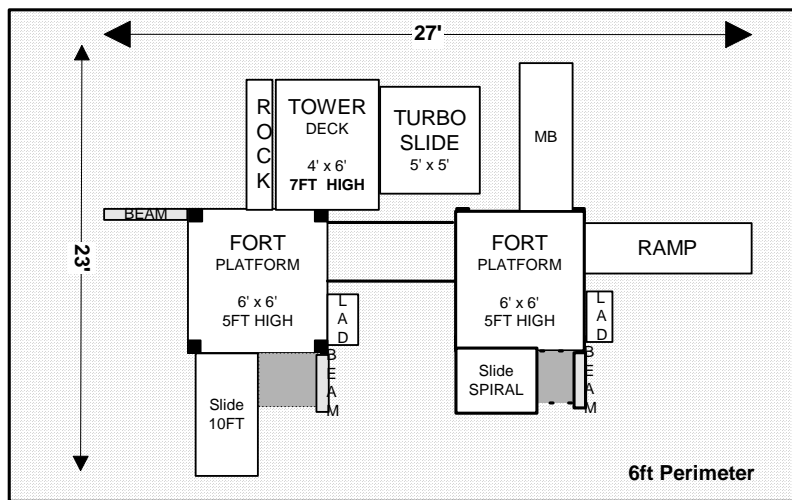

27-31L x 18W

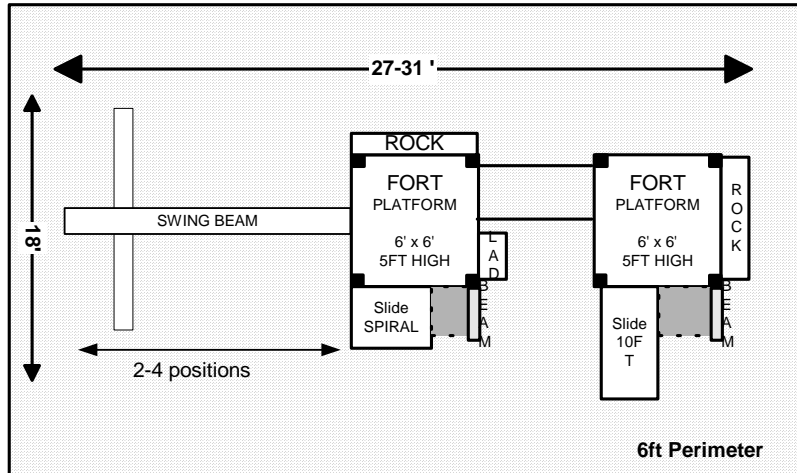

WWW.DETAILEDPLAY.COM
TOP QUALITY SITE PLANS DESIGNS KITS
FORT TOWER SWINGSET KITS OVERVIEW



JUNGLE FORT SWINGSET



JUNGLE FORT SWINGSET + TOWER



JUNGLE FORT CAMPUS



JUNGLE FORT SWINGSET + ROCK WALL



JUNGLE FORT CAMPUS + TOWER



JUNGLE FORT TOWER

DETAILED PLAY SYSTEMS - (800)398-7565 - WWW.DETAILEDPLAY.COM
PLANS KITS ACCESSORIES TO BUILD ANY COMBINATION OF:
FORT-SWINGSET-TOWER-SANDBOX-LADDER-RAMP-MONKEY BARS-ROCK WALL-TIRE SWING-PICNIC TABLE

WWW.DETAILEDPLAY.COM
TOP QUALITY PLAYGROUND EQUIPMENT
SWINGS SLIDES HARDWARE ACCESSORIES OVERVIEW



DETAILED PLAY SYSTEMS - (800)398-7565 - WWW.DETAILEDPLAY.COM
THE BUILD@HOME™ PLAYGROUND EQUIPMENT STORE