

# JUNGLE FORT®

BACKYARD PLAYGROUND BUILDING KITS



COPYRIGHT ©1998 DETAILED PLAY SYSTEMS  
ALL RIGHTS RESERVED.

## INTRODUCTION

Thank you for downloading our planning guide and for your interest in Detailed Play Systems!

Detailed Play Systems products deliver superior backyard playground quality and value. The Jungle Fort Swingset is our most popular playground configuration. Our forts, towers, and swing sets are the most solidly designed "Just Add Lumber" Kit backyard playgrounds available and the features of the finished product are comparable to those found in expensive brand name sets. Adding strength and longevity requires more bolting and hardware in our kits, a worthwhile investment especially when investing the time to build. Build once using our products, Jungle Fort play structures should not be expected to ever need replacement.

Please call or visit our website to see our complete line of plan compatible kits, swings, slides, hardware, and accessories for any backyard playground available at [www.detailedplay.com](http://www.detailedplay.com)

Build Memories! Thanks again for your interest in Detailed Play Systems.

### Detailed Play Systems

Web: [www.detailedplay.com](http://www.detailedplay.com)

Telephone: 1-800-398-7565

Email: [playsets@detailedplay.com](mailto:playsets@detailedplay.com)

Facebook: [www.facebook.com/DetailedPlay](http://www.facebook.com/DetailedPlay)

### FREE PLAN BOOK PDF

Free Detailed Plans PDF included with Any Kit Purchase! [www.detailedplay.com/swing-sets.htm](http://www.detailedplay.com/swing-sets.htm)

Please share this planning guide with your friends and family:



[Email](#)



[Facebook](#)



[Twitter](#)



[Stumble](#)



[Digg](#)

## OVERVIEW

A spiral bound hardcopy of the plan book is included with all kit purchases. Main sections to see include: **Site Plans, Table of Contents, Materials List, Lumber Purchase Form, Parts List, Drill Diagrams.**

Our **Parts Processing Checklist** is a one page snapshot of all lumber preparation that is needed prior to bolting/assembly. **Step by Step instructions** and **Assembly Diagrams** are provided in easy to follow Front, Left, Right, Rear View format. Our plans have been carefully laid out and well documented helping to eliminate problems and minimize project time. The plans are easy to follow only basic carpentry skills and tools are required.

- 1) Select Site, Site Plan, Features and Accessories. Our plans contain detailed **Site Plan** options helping to select and optimize playground features and customize play site layout.
- 2) Quote and Purchase Lumber, Kits, Accessories. Use the **Lumber Purchase Form** and our website at [www.detailedplay.com](http://www.detailedplay.com) to shop for materials and accessories that are compatible with our plans.
- 3) Cut lumber to size and label using the **Parts List**. Round corners of specified parts using miter or circular saw, a router is not required. Use **Parts Processing Checklist** as a guide.
- 4) Drill countersink and though holes in parts as specified in **Drill Views**.
- 5) Assemble using **Step by Step Instructions** and **Assembly Diagrams**.
- 6) Apply an appropriate water seal product for wood, install soft playground surfacing for safety.

**WWW.DETAILEDPLAY.COM**  
**TOP QUALITY SITE PLANS DESIGNS KITS**  
**FORT TOWER SWINGSET KITS OVERVIEW**



**JUNGLE FORT SWINGSET**



**JUNGLE FORT SWINGSET + TOWER**



**JUNGLE FORT CAMPUS**



**JUNGLE FORT SWINGSET + ROCK WALL**



**JUNGLE FORT CAMPUS + TOWER**



**JUNGLE FORT TOWER**

**DETAILED PLAY SYSTEMS - (800)398-7565 - WWW.DETAILEDPLAY.COM**  
**PLANS KITS ACCESSORIES TO BUILD ANY COMBINATION OF:**  
**FORT-SWINGSET-TOWER-SANDBOX-LADDER-RAMP-MONKEY BARS-ROCK WALL-TIRE SWING-PICNIC TABLE**

WWW.DETAILEDPLAY.COM  
TOP QUALITY PLAYGROUND EQUIPMENT  
SWINGS SLIDES HARDWARE ACCESSORIES OVERVIEW



DETAILED PLAY SYSTEMS - (800)398-7565 - WWW.DETAILEDPLAY.COM  
THE BUILD@HOME™ PLAYGROUND EQUIPMENT STORE

# PLANNING GUIDE

FOR

# JUNGLE FORT® SWINGSET

FORT SWINGSET SANDBOX LADDER RAMP  
MONKEY BARS ROCK WALL PICNIC TABLE TUBE TUNNEL

JUST ADD LUMBER!™

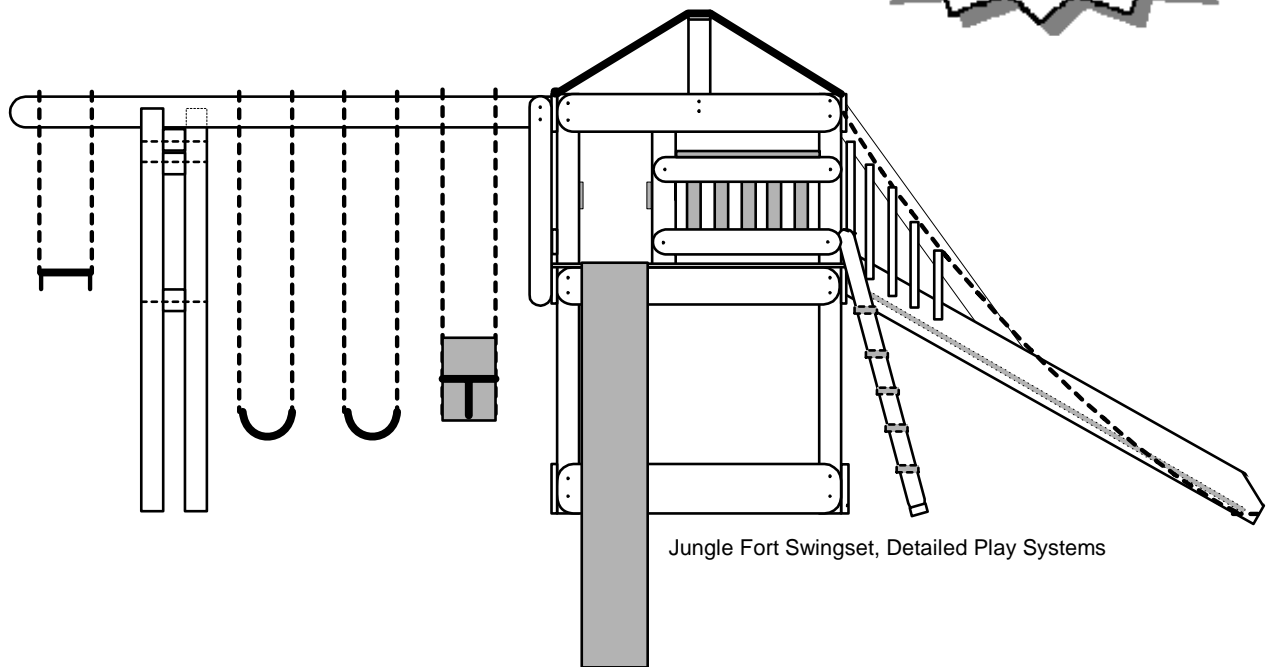

## DETAILED PLAY SYSTEMS

VISIT THE BUILD@HOME™ PLAYGROUND EQUIPMENT STORE AND SAVE!

[WWW.DETAILEDPLAY.COM](http://WWW.DETAILEDPLAY.COM)

# Jungle Fort® Swingset – Table of Contents

<b>Playground Planning</b>	5
Before You Begin	5
<b>Site Plans</b>	7
<b>Lumber Purchase Form</b>	11
<b>Jungle Fort® , Lumber Preparation</b>	13
Materials List	14
<b>Cutting &amp; Labeling Instructions</b>	15
<b>Parts List</b>	16
Round & Sand Instructions	17
Additional Cutting	17
<b>Drilling Instructions</b>	20
Drill Views (3)	21
Anchoring Method	25
<b>Parts Processing Checklist</b>	26
<b>Part Label Cross Reference</b>	28
<b>Jungle Fort® , Installation &amp; Assembly</b>	30
<b>Build Frame/Structural Support</b>	30
Front Views (2)	33
Left View	35
Rear Views (3 w/ <b>Tower Rear View</b> )	36
Right Views (5 w/ <b>Campus Tube Tunnel</b> )	39
<b>Build Fort Platform (Deck)</b>	44
Top Platform View	45
<b>Build Fort Walls</b>	46
<b>Build Roof Support &amp; Install Tarp</b>	48
Mega Top	49
<b>Assemble Ladder &amp; Handrails</b>	50
Ladder View	51
<b>Assemble Gangplank Ramp</b>	53
Ramp/Climber Views (2)	54
<b>Slides, Hangers, &amp; Accessories</b>	57
<b>Swingset, Lumber &amp; Installation</b>	59
<b>Materials &amp; Parts List</b>	59
Lumber Preparation & Drilling	60
Drill View	61
<b>Installation &amp; Assembly</b>	64
Left Views (2)	65
Front View	67
Top View	70
Accessory Views (2)	71
<b>Monkey Bars, Lumber &amp; Installation</b>	75
<b>Materials &amp; Parts List</b>	75
Lumber Preparation & Drilling	76
Drill View	77
<b>Installation &amp; Assembly</b>	78
Front, Top, Right Views	79
<b>Rock Wall, Lumber &amp; Installation</b>	84
<b>Jungle Fort® , Appendices</b>	88

# PLANNING GUIDE

FOR

# JUNGLE SWINGSET SLIDE

SWINGSET: 10'H, 12'L, 4x6 - 3 POSITIONS/TIRE SWING  
3' x 5' SLIDE PLATFORM - 5FT DECK HEIGHT  
ROCK WALL SLIDING POLE MONKEY BARS SLIDE HOOD

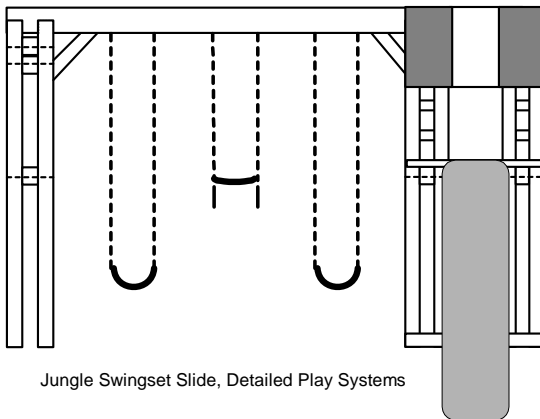

Jungle Swingset Slide, Detailed Play Systems

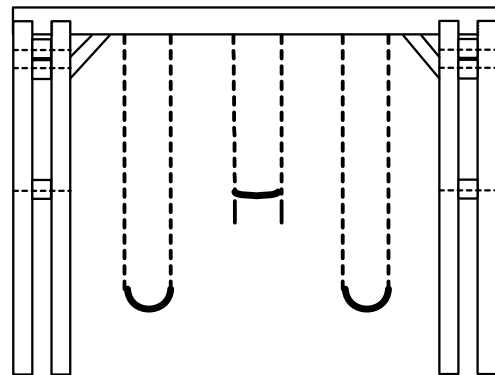

Jungle Swingset, Detailed Play Systems

## DETAILED PLAY SYSTEMS

VISIT THE BUILD@HOME™ PLAYGROUND EQUIPMENT STORE AND SAVE!

[WWW.DETAILEDPLAY.COM](http://WWW.DETAILEDPLAY.COM)

# Jungle Swingset Slide – Table of Contents

<b>Playground Planning</b> .....	5
Before You Begin .....	5
<b>Site Plans</b> .....	7
<b>Lumber Purchase Form</b> .....	8
<b>Jungle Swingset Slide - Lumber Preparation</b> .....	10
<b>Materials &amp; Parts List</b> .....	10
<b>Cutting &amp; Labeling Instructions</b> .....	11
<b>Drilling Instructions</b> .....	11
Drill View .....	12
<b>Round &amp; Sand Instructions</b> .....	14
<b>Jungle Swingset Slide - Installation &amp; Assembly</b> .....	15
<b>Build A-Frames</b> .....	15
Swingset Left/Right View .....	16
<b>Slide Platform – Position, Anchor, Brace A-Frames</b> .....	17
Slide Platform – Rear View .....	18
Slide Platform – Front View .....	19
Slide Platform – Side View .....	20
<b>Slide Platform – Ladder, Deck</b> .....	21
<b>Slide Platform – Top A-Frame Braces, Railings</b> .....	21
<b>Slide Platform – Roof Supports, Vinyl Roof Top</b> .....	22
<b>Slide Platform – Safety Handgrips, Slide</b> .....	23
<b>Swingset - Install Swing Hangers</b> .....	23
<b>Swingset - Position, Anchor, Temp Brace A-Frame(s)</b> .....	24
Swingset - Top View .....	25
Swingset - Front View .....	26
<b>Swingset - Hoist Swing Beam</b> .....	27
Swingset - Fasten Swing Beam to A-Frames .....	27
<b>Slide Platform – Rock Wall</b> .....	30
<b>Slide Platform – Sliding Pole</b> .....	32
<b>Slide Platform – Monkey Bars</b> .....	34
<b>Jungle Swingset, Appendices</b> .....	43



# DETAILED PLAY SYSTEMS PLAYGROUND PLANNING

SITE SELECTION

SITE PLAN SELECTION

JUNGLE FORT FEATURES/OPTIONS

LUMBER PURCHASE

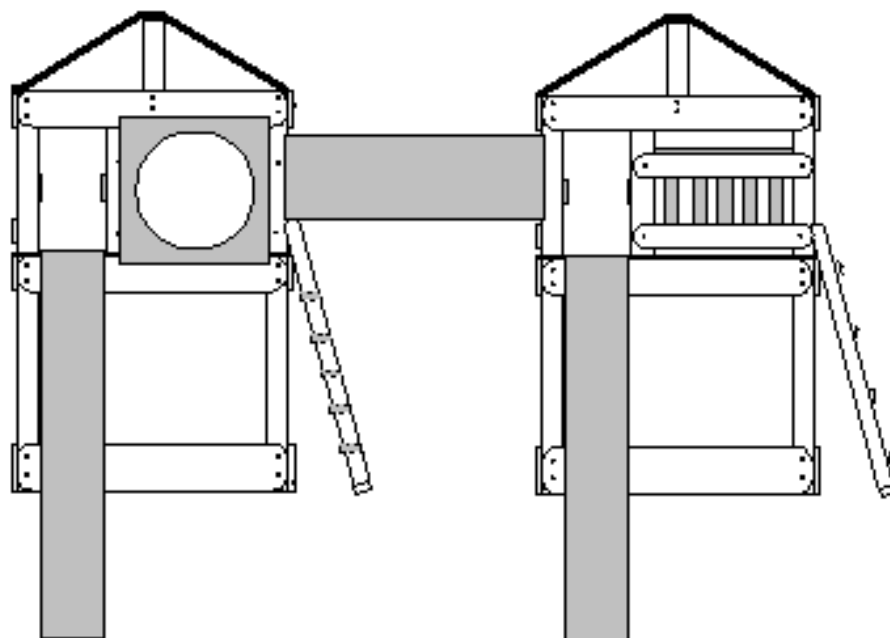

# Jungle Fort

## Before You Begin

### **HAVE FUN – BUILD MEMORIES**

The Jungle Fort Swingset will provide you, your children, and their friends with many years of safe fun, adventure, and play. The Jungle Fort's solid, distinctive and attractive design; its affordability without sacrificing quality; coupled with Detailed Play Systems' innovative family-oriented project approach to acquiring a professional quality playground, will help to create long term backyard memories and fun for your family. Building a Jungle Fort is a truly rewarding experience. It's a backyard playground that children and parents will take pride in and love to own – you are 'the inventor' in the eyes of the children. You have made an excellent choice in your decision to build a Jungle Fort using this Detailed Plan. We strive to deliver to families not only the initial enjoyment of custom designing features and building a playground together, but a satisfying long term playground ownership experience and a whole lot of fun for the kids. Be sure to supervise and teach your children and their friends about how to play appropriately on all playground equipment. Remember to maintain the safety of your new backyard playground by routinely inspecting and repairing promptly if necessary. Build Memories! Build a Jungle Fort Swingset with Detailed Play Systems.

### **OUR COMMITMENT TO SAFETY AND YOUR RESPONSIBILITY**

Detailed Play Systems is following the standards developed by the CPSC and ASTM (F1148) regarding safe design of home playground equipment to assure that this plan will produce a safe product when manufactured and installed correctly. The builder assumes responsibility for installing this product as specified and for the safety and inspection of the product installation.

**Prior to beginning, the builder should become familiar with the content and methods in the Detailed Plan, and the standards information provided in the *Appendices* relating to site selection and maintenance, surface materials and general guidelines for playground safety. The owners of the Jungle Fort Swingset must be provided with a copy of the information in the *Appendices* and be instructed to follow these standard guidelines.**

### **BUILD YOURSELF OR HIRE A CONTRACTOR**

You must:

- Be at least 18 years of age to build the Jungle Fort.
- Read the plans thoroughly prior to beginning and be confident in your ability to understand the diagrams and follow the instructions.
- Be confident in your ability to perform basic carpentry techniques such as lifting, measuring, cutting, and drilling prior to beginning.
- Own, and be able to safely operate power tools such as miter saw, circular saw, and drill (a powerful cordless drill with keyless chuck will save a lot of time on this project). Follow the tool manufacturer's operation and safety instructions. Use of safety glasses and dust mask are recommended for cutting and drilling lumber.
- Be able to lift heavy objects such as 12 foot 2x8's.
- Select lumber that is suitable for outdoor playground use and is available in the dimensions specified on the Lumber Purchase Form. Inquire at local lumber supply and visit our website for more information about lumber selection options and to learn which lumbers are commonly used in your area for wooden playground construction.
- Assemble the Jungle Fort using galvanized hardware at specified dimensions and locations.
- Choose to hire a professional contractor if you unsure about these or any other instructions.

# Installation Site, Site Plan, and Build Options

(Choose the installation site using all five of these considerations for playground location)

1. **LEVEL:** The installation site must be leveled prior to beginning this project.
2. **FIRM SURFACE, NOT HARD:** The installation site must not be over concrete, asphalt, packed earth, or any other hard surface. After playground is installed, install shock absorbent loose fill surfacing to cover the “use-zone” area outlined on Site Plan, see Appendices A-E.
3. **UNOBSTRUCTED:** Your installation site must be not less than 6 ft. from any structure or obstruction such as a fence, garage, house, tree branches, laundry lines, electrical wires.
4. **ANCHORED:** You should anchor this structure to the ground using wooden stakes, *pg 25*.
5. **VIEWABLE FROM “KITCHEN WINDOW”:** Make ongoing supervision more convenient.

Refer to **Site Plan** for site plan configurations. Choose a site plan and the build options you would like, measure the use zone, fort, and anchor locations at the site making sure to allow for at least 6ft. of unobstructed area around the play structure. Test if your site is level and correct any overall grading problems as necessary. You may use actual wood or string, stakes, and a line level to simulate the base of the Fort near the ground. To achieve design stability, the base parts of the Fort must be level.

## BUILD OPTIONS

The following build options, and all combinations, are possible. Make sure the build option(s) you select will work with your site plan selection.

JUNGLE FORT PLAYGROUNDS - BUILD OPTIONS
Jungle Fort (6x6x5'DH), Inclined Step Ladder
Sandbox (6x6x8" deep) / Gangplank Ramp - Climber
Monkey Bars / Rock Wall / Picnic Table
Jungle Fort Swingset – 8'H x 8-12-16'L Swingset (Attached to Fort)
Jungle Fort Tower (4x6x7'DH) and/or Jungle Fort Campus
-----
Jungle Swingset - 8-9-10'H Swingset (Standalone)
Slide Platform, 3x5x5'DH (Attached to 10'H Jungle Swingset)
Slide Platform, Rock Wall / Sliding Pole / Monkey Bars

## PLAN SUITABLE ACCESSORIES

This product is intended for children ages 5-12, but younger children can play too if provided with close supervision and parental assistance. Be sure to consider your child's age and physical abilities before installing the more challenging accessories. Plan to change the accessories over time to help keep the play age-appropriate. Refer to the **Accessory Plan** for further information on accessories and locating the accessories on beams.

Jungle Fort  
SITE PLANS

11L x 15W

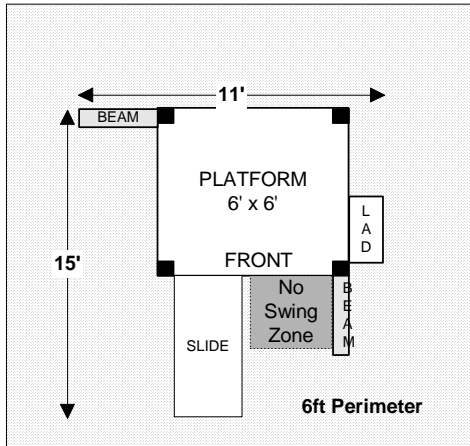

18L x 9W

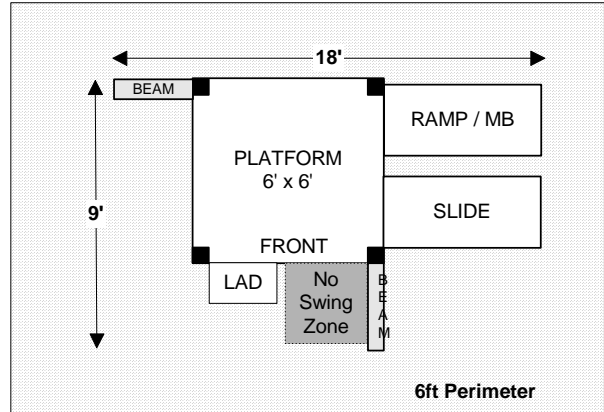

18L x 15W

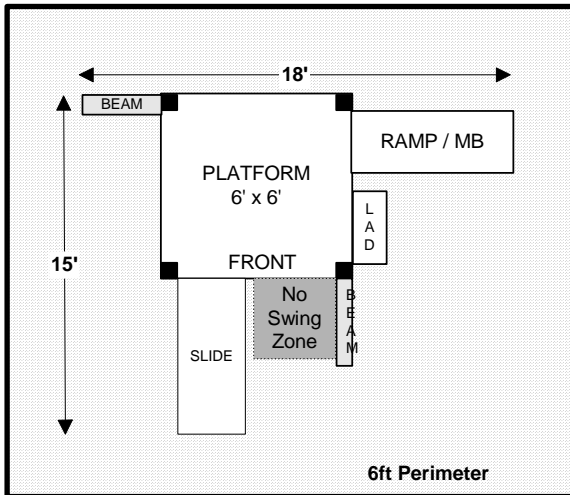

18L x 17W

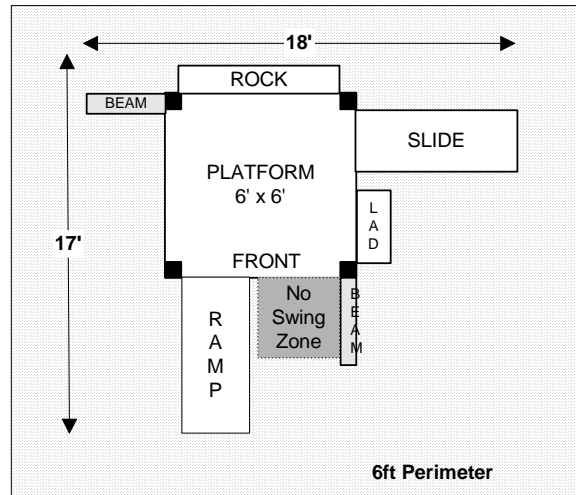

18L x 15W

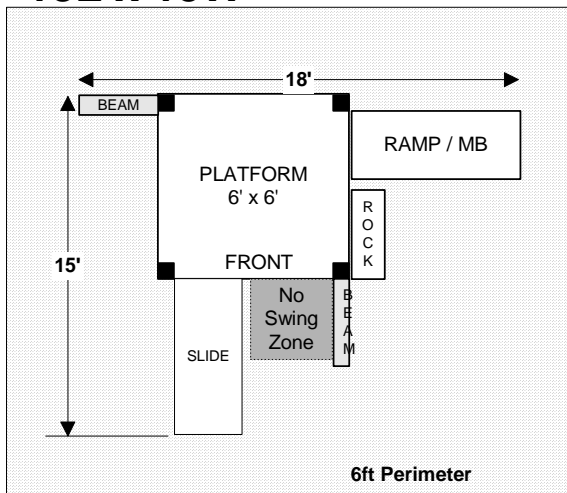

18L x 22W

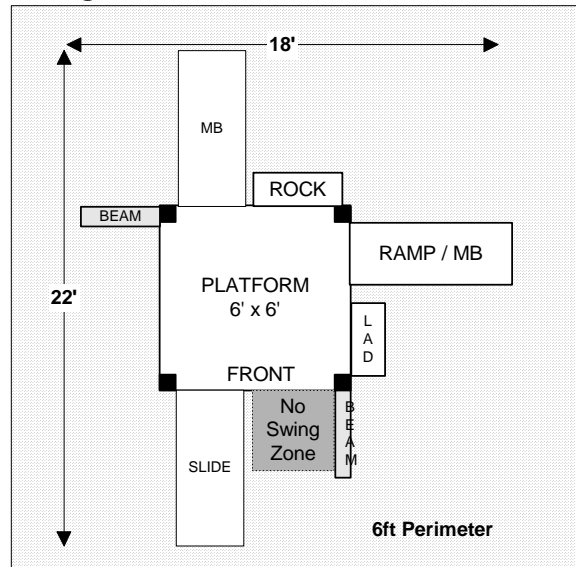

Jungle Fort Swingset  
SITE PLANS

**16L x 17W**

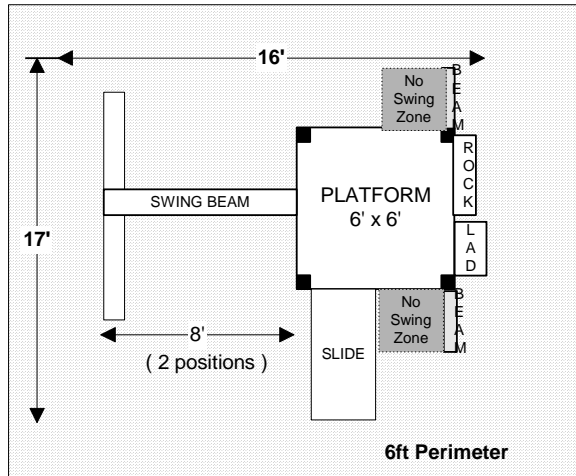

**22-30L x 14W**

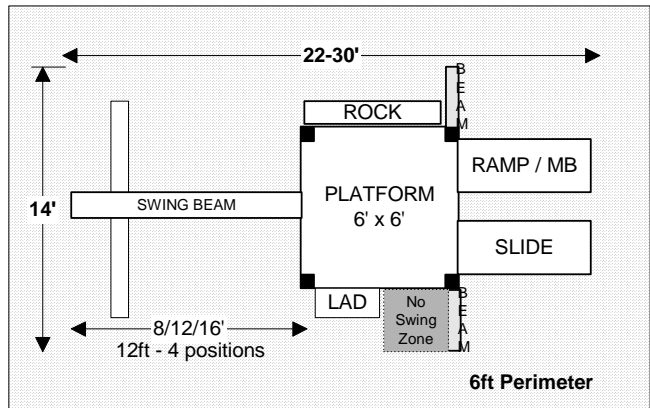

**22-30L x 17W**

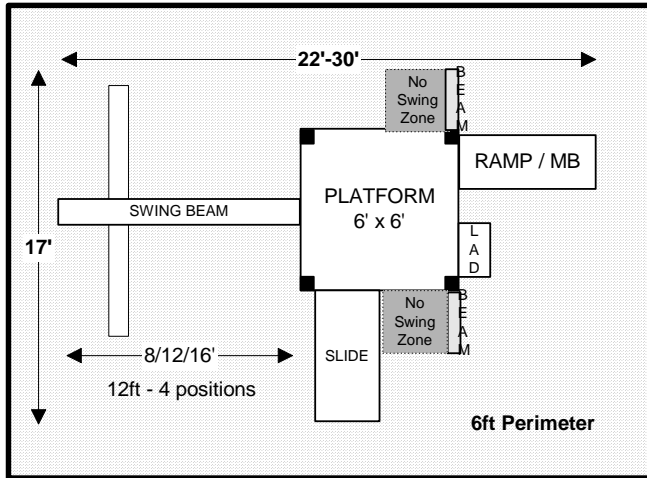

**22-30L x 17W**

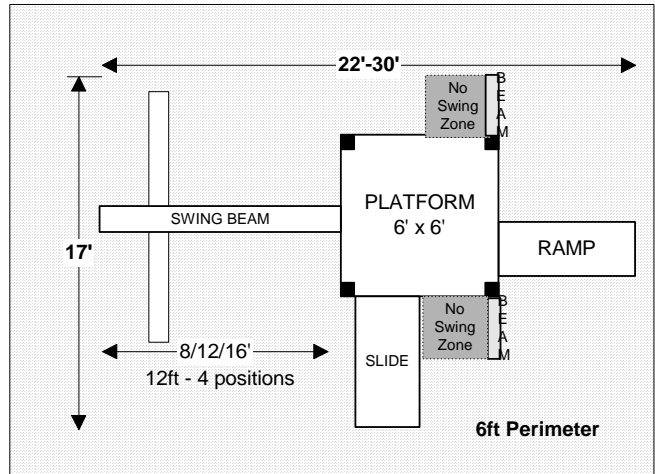

**22-30L x 17W**

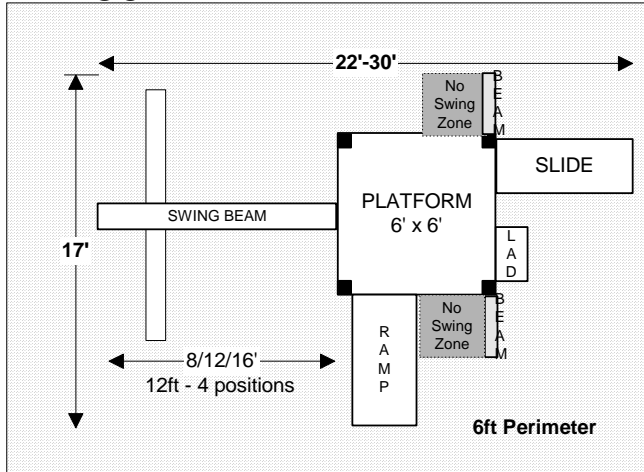

**22-30L x 22W**

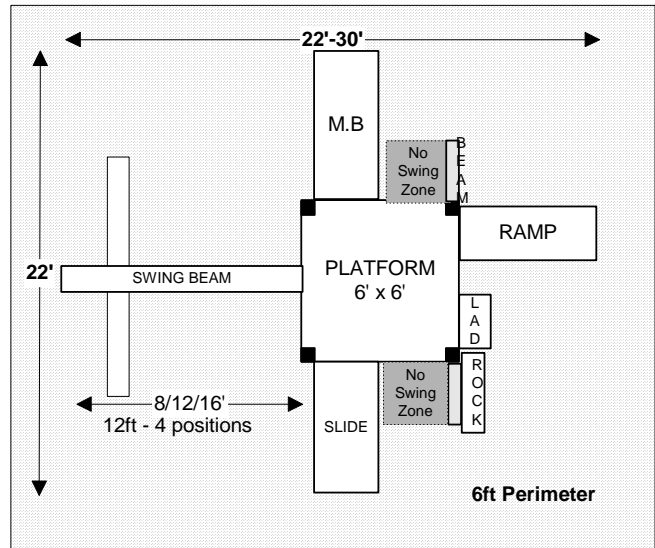

\* Swing Beam can be 8ft (2 pos), 12ft (4 pos), 16ft (5 pos) or moved to RIGHT side.

# Jungle Fort Tower SITE PLANS

## 30-35L x 22W

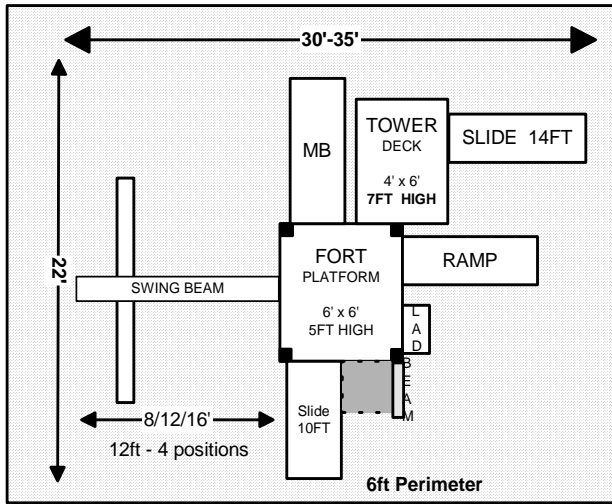

## 26-30L x 20W

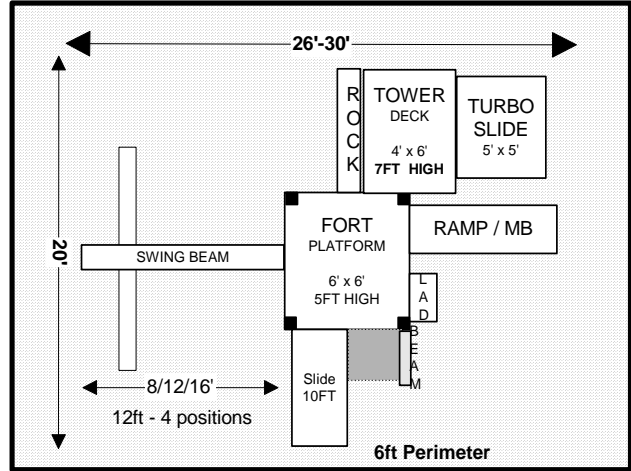

## 17L x 22W

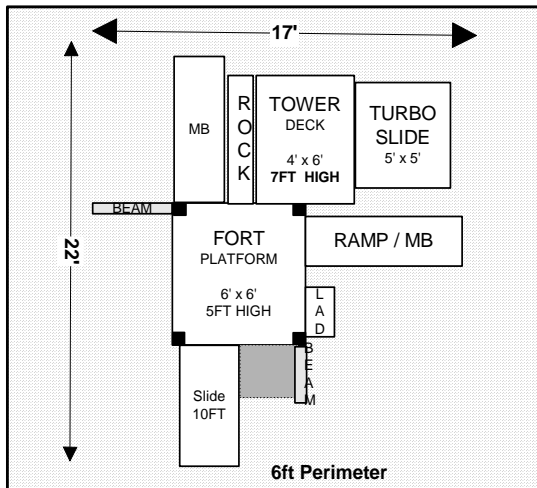

## 30L x 22W

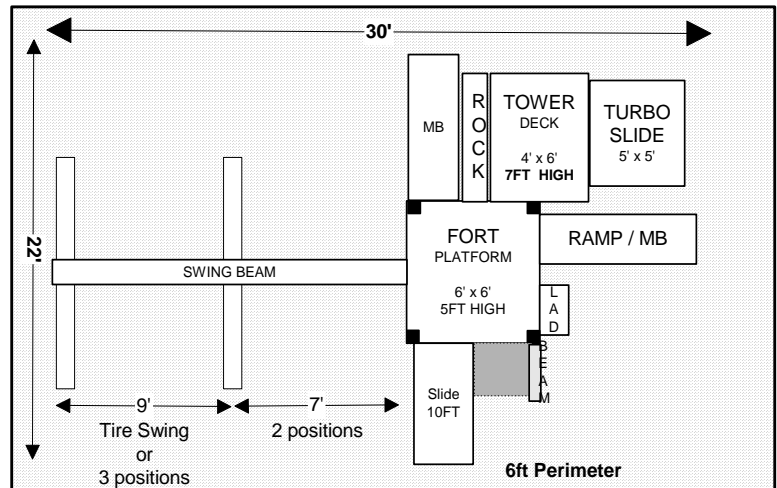

## 17L x 14W

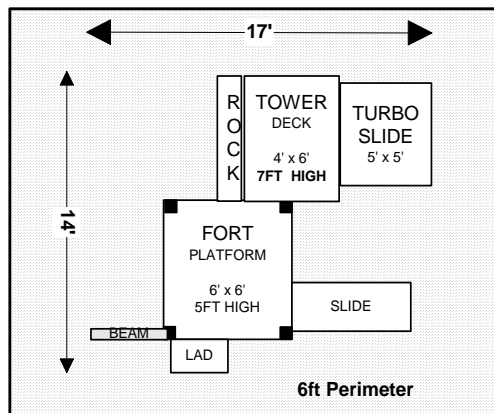

Jungle Fort Campus  
SITE PLANS

19L x 16W

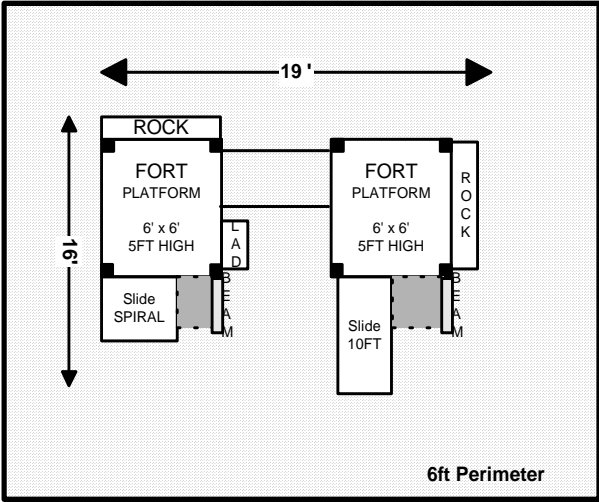

21L x 18W

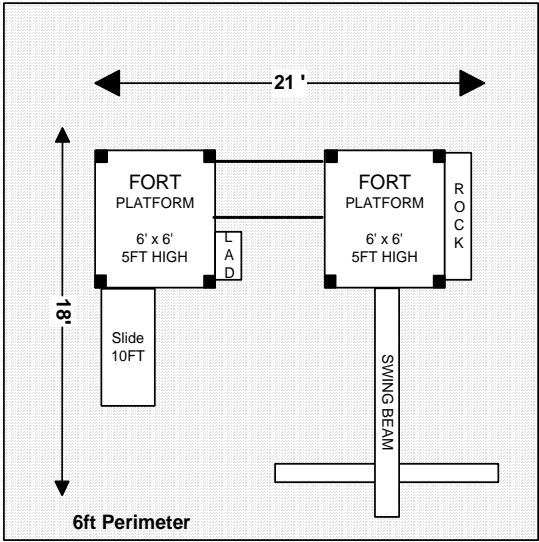

27L x 23W

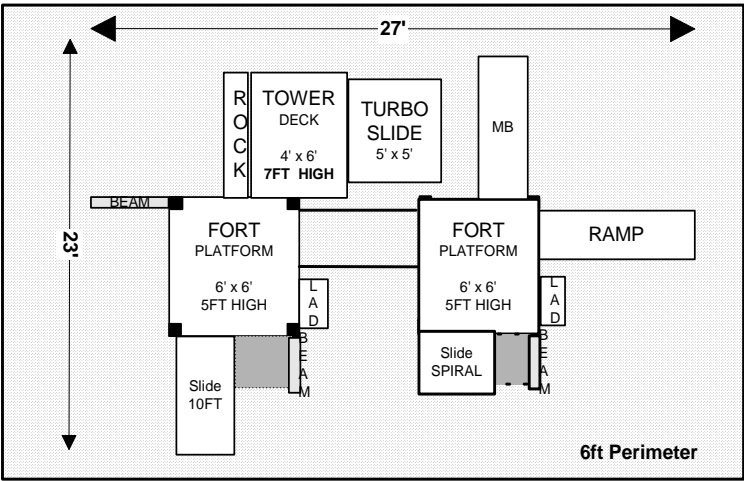

27-31L x 18W

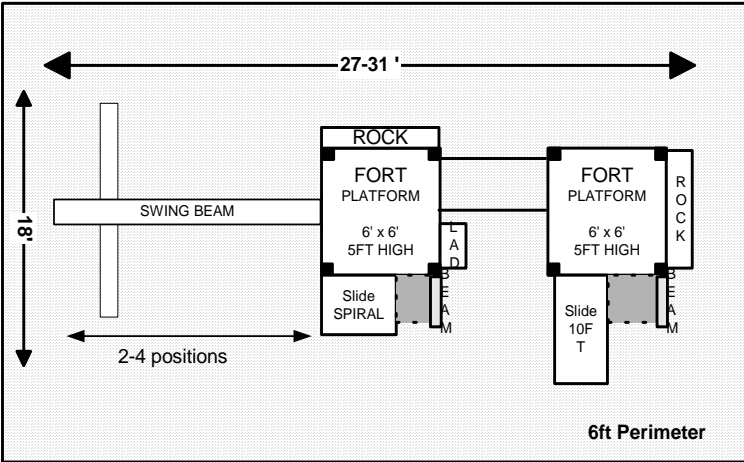

# Jungle Swingset Slide SITE PLANS

## 12L x 11-17W

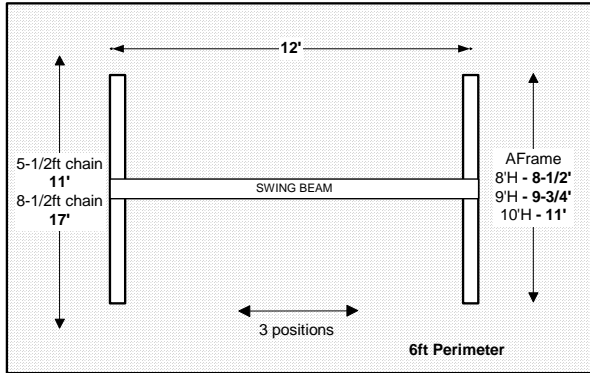

## 15L x 20W

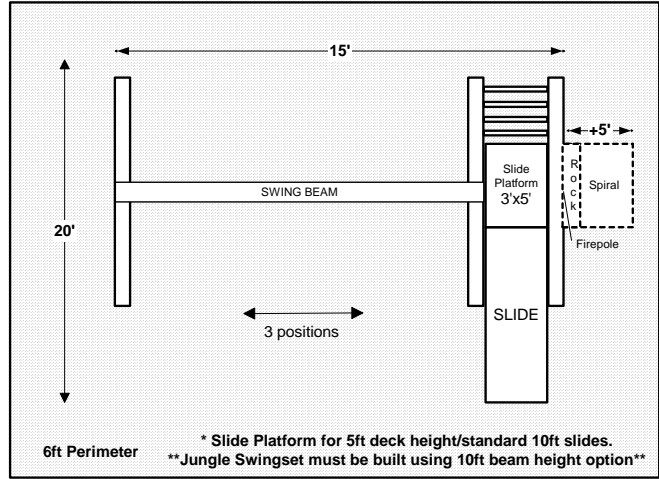

## 18L x 22W

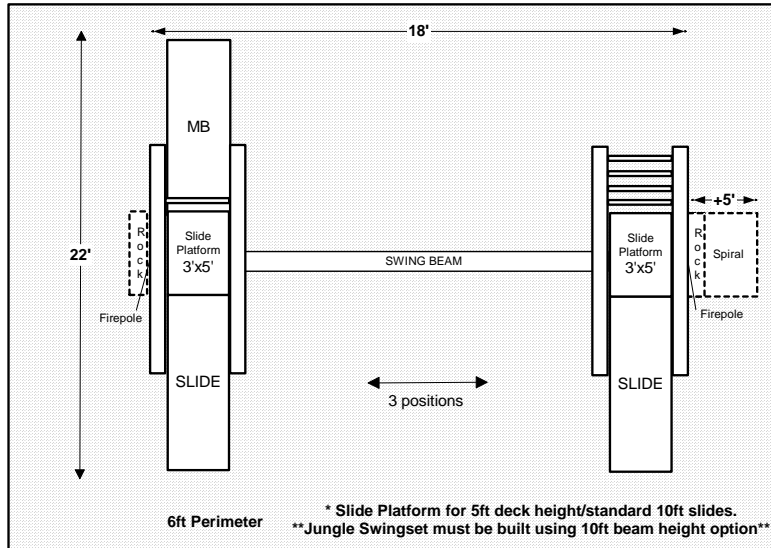

## 26L x 22W

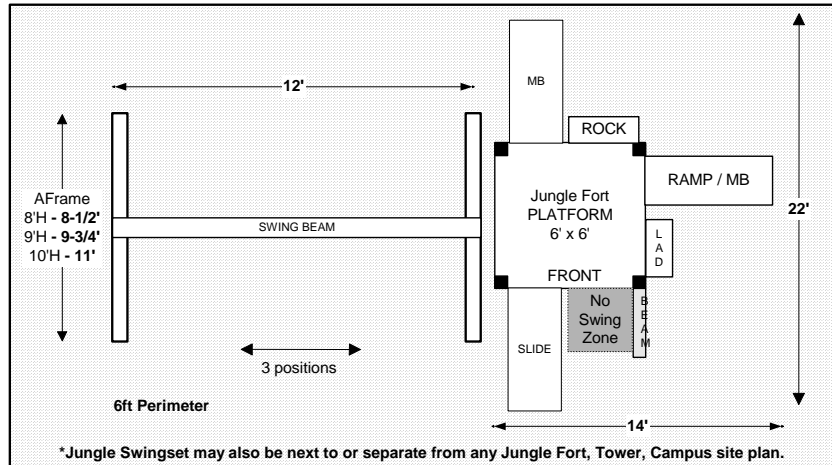



# DETAILED PLAY SYSTEMS

PO Box 633, SPRINGFIELD NJ 07081  
 800.398.7565 973.912.9440  
 973.376.8881 (FAX)  
 EMAIL: PLAYSETS@DETAILEDPLAY.COM

## LUMBER PURCHASE FORM



# WWW.DETAILEDPLAY.COM

**Jungle Fort® Swingset Tower** [ Add lumber for options (1-10), per customer Site Plans

**1- JUNGLE FORT® (Ladder/Sandbox)**  
Treated Pine / (WPL Option)  
 Least expensive & strongest option, treated & sealed.

4 x 4 x 8' (10' for MegaTop)	(4)	
2 x 8 x 12'	(2)	
2 x 6 x 12'	(8)	
2 x 4 x 12'	(12)	or (4) Pine / (8) WPL
5/4 x 6 x 12' **	(6)	or (0) Pine / (6) WPL
2 x 2 x 8'	(2)	
2 x 4 x 12'		<b>Add (3) for MegaTop</b>

WPL – Wood Polymer Lumber - Composite decking, optional upgrade. For non-structural parts only.

**2- GANGPLANK RAMP**

2 x 6 x 12'	(2)	
2 x 4 x 12'	(2)	
5/4 x 6 x 12' **	(3)	
2 x 2 x 8'	(5)	

**3- MONKEY BARS**

4 x 4 x 8'	(5)	Fort -or- (4) Slide Plat.
2 x 4 x 12'	(2)	

**4- ROCK WALL**

2 x 4 x 12'	(3)	
5/4 x 6 x 12'	(5)	(8' Fort) -or-
	(7)	(5' / 8' Fort Combo) -or-
5/4 x 6 x 10'	(6)	(5' Fort/Slide Plat.) -or-
	(8)	(7', Tower)

**5- TOWER**

4 x 4 x 12'	(4)	
2 x 8 x 12'	(2)	
2 x 6 x 12'	(5)	
2 x 4 x 12'	(11)	or (5) Pine / (6) WPL
5/4 x 6 x 12' **	(4)	or (0) Pine / (4) WPL

\* if Pine is not available, select lumber in use locally for outdoor playgrounds (eg. cedar, redwood)  
 \*\* use 2x6x12' if 5/4x6x12' is not available.

**6- SWINGSET 8'H, 8-16'L Attached to Fort**  
 (One A-Frame & Swing Beam)

4 x 4 x 10'	(4)	
2 x 4 x 12'	(1)	
4 x 6 x 12' (8' or 16')	(1)	

(2nd A-Frame – adds separate Tire Swing bay)

4 x 4 x 10'	(+3)	
-------------	------	--

**7- SLIDES** (Models that require lumber)

2 x 4 x 8'	(2)	(10 FT SCOOP)
2 x 4 x 12'	(2)	(14 FT SCOOP)
2 x 6 x 12'	(1)	(TURBO)

**8- PICNIC TABLE**

2 x 6 x 12'	(3)	or (1) Pine / (2) WPL
5/4 x 6 x 12' **	(3)	or (0) Pine / (3) WPL
2 x 4 x 12'	(1)	
2 x 4 x 8'	(2)	

**9- SWINGSET 8-10'H, 12'L Standalone**

8' High:	4 x 4 x 10'	(7) -or-	or attach to
9' High:	4 x 4 x 12'	(4)	Fort/Tower
	4 x 4 x 10' +	(3) -or-	
10' High:	4 x 4 x 12'	(7)	Temp. Bracing:
All Heights:	4 x 6 x 12'	(1)	2x4x12' (1)

**10- SLIDE PLATFORM Add to Standalone 10'H Swingset**

4x4x12'	(3)	
2x6x12'	(3)	
2x4x12'	(4)	

\* Treated Pine is strong economical lumber suited for outdoor use. WPL is a low maintenance durable splinter free option for playset decks. Pine, Cedar, Redwood, Douglas Fir, and WPL may be used. Do not use 'soft' lumber for swing beam. For further lumber info, click on the green "Detailed Lumber Guide" graphic on the Plans page of our web. Clean, water seal annual or as required.

**TOTAL: (Add items 1 - 10)**

Detailed Plan for Jungle Fort Swingset, Jungle Fort Tower, Jungle Swingset Slide, Copyright ©1998 PlayBuilder Inc.

*Use this form to quote or purchase lumber at your local lumber supply.*

# Jungle Fort – Materials List

**Note: Lumber Purchase Form has lumber list for ALL playground options.**

## FORT Lumber

### Use ALL Treated Pine

(optionally: Cedar, Redwood, Douglas Fir)

	Ladder Only	Ramp	Rock	Mega
4x4x8' (10' Mega)	(4)			
2x8x12'	(2)			
2x6x12'	(8)	(+2)		
2x4x12'	(12)	(+2)	(+3)	(+3)
5/4x6x12'	(6)	(+3)	(+5)	
2x2x8'	(2)	(+5)		

- OR -

### Use MIX of Pine / Wood-Polymer (WPL)

(low maintenance durable splinter free option)

Pine	Ladder Only	Ramp	Rock	Mega
4x4x8' (10' Mega)	(4)			
2x8x12'	(2)			
2x6x12'	(8)	(+2)		
2x4x12'	(6)	(+2)	(+3)	(+3)
5/4x6x12'	(0)	(+3)	(+5)	
2x2x8'	(2)	(+5)		

### WPL

5/4x6x12'	(6)
2x4	88 linear ft.

These are the building materials, tools, hardware, and accessories you will need to complete the Jungle Fort project. The Treated Pine is used for structural components. Wood-polymer lumber can be used for the floor and walls of the Fort where skin contact occurs most. Use strong and durable lumber.

## Jungle Fort Kit - Hardware

- (49) 3/8" x 5" Hot Dipped Galv (HDG) Carriage Bolts
- (7) 3/8" x 3" Hot Dipped Galv. (HDG) Carriage Bolts
- (56) 3/8" HDG Washer, Lock Washer & Nuts
- (8) 2"x6" HDG Joist Hangers
- (10) 1 1/2" x 2" HDG Corner Braces
- (2) 3" x 2" HDG Corner Braces
- (8) 5" x 3/8" HDG Lag Screws
- (16) 2 1/2" x 3/8" HDG Lag Screws
- (400) 2 1/2" HDG Drywall Decking Screws
- (120) 1 1/2" HDG Joist Hanger Nails
- (2) 4" Swing Hangers w/ Lag Screw

\* See full size photographs of hardware in back of plan book.  
(hardware images not available in electronic PDF version)

Visit [www.detailedplay.com/Playsets.htm](http://www.detailedplay.com/Playsets.htm)

## Tools

Miter Saw or Circular Saw with Carbide Blade  
 Power Drill, Philips Head Bit, Standard Wood Bit Set - 1/8", 1/4"  
 Wood Boring Spade/Paddle Bits:  
 7/16" & 1-1/8" (Fort), 9/16" & 1-1/2" (Swingset/MB), 7/8" (MonkeyBars)  
 Socket Wrench Set - 9/16" (Fort), 3/4" (Swingset/MB) Deep Sockets  
 Pencil, Tape Measure, Level, Hammer, Safety Glasses/Mask, Cord  
 Sandpaper, Jig Saw or Hand Saw, optional Router

## Accessories

59" x 103" Vinyl Roof Top	(1)
Nylon Rope 5/8" x 15' (Ramp)	(1)
Handgrips (1"-dia. x 10" / slide & ladder)	(4)
10' Slide (60" platform)	(1)

## Optional Accessories

Swings, Rope Ladder, Steering Wheel, Trapeze Bar with Rings,  
 Telescope, Climbing Rope

Project Kits and Accessories  
[WWW.DETAILEDPLAY.COM](http://WWW.DETAILEDPLAY.COM)

**Builder Kits:** Fort & Swingset  
 Base Kits, Customize your  
 accessories!

**Fort Swingset Kit:** To build  
 Jungle Fort and Swingset,  
 Sandbox, Ladder, Ramp.

**Fort Kit:** To build Jungle Fort,  
 Sandbox Ladder, Ramp.

**Monkey Bar, Rock Wall,  
 Tower Kits:** Add-on at any  
 time!

## Jungle Fort Swingset – Materials List

(Swingset attached to Jungle Fort - 8' beam height, 8'-12'-16'L, 2-4 positions)

### SWINGSET Lumber

#### Treated Pine

4x4x10' (4)

2x4x12' (1)

4x6x12' (16' or 8') (1)

**-or-**

2x6x12' (16' or 8') (2)

**Note:** Use of Treated Pine 4x6 is recommended for maximum strength swing beam.

### Jungle Fort Swingset Kit - Hardware includes Jungle Fort Kit Hardware, plus:

- (6) 1/2"x5" Hot Dipped Galv. Carriage Bolts
- (6) 1/2"x7" Hot Dipped Galv. Carriage Bolts
- (3) 1/2"x 11" Hot Dipped Galv Carriage Bolts
- (15) 1/2" HDG Washer, Lock Washer, & Nuts
- (18) 3/8"x5" HDG Lag Screws
- (12) 3/8"x2 1/2" HDG Lag Screws
- (6) 6" HDG Swing Hangers w/ Bolt, Washer, Lock Nut  
(Optional: Ductile Iron or Composite Steel Hangers)

### Swingset Accessories

Swings, Trapeze with Rings, Climbing Rope

Visit <http://detailedplay.com/Swingsets.htm>

## Jungle Fort Tower – Materials List

(7' deck height 4'x6'Tower attached to Jungle Fort)

### TOWER Lumber

#### Use ALL Treated Pine

4x4x12' (4)

2x8x12' (2)

2x6x12' (5) (+1 for Turbo Slide)

2x4x12' (11)

5/4x6x12' \* (4)

**- OR -**

#### Use MIX of Pine / Wood-Polymer (WPL)

(low maintenance durable splinter free option)

#### **Pine**

4x4x12' (4)

2x8x12' (2)

2x6x12' (5) (+1 for Turbo Slide)

2x4x12' (5)

#### **WPL**

5/4x6x12' (4)

2x4x12' (6)

These are the building materials, tools, hardware, and accessories that you will need to complete the Jungle Fort Tower project. The treated pine used in the project is for structural components. Wood-polymer lumber can be used for the floor and walls where skin contact occurs most. Use strong and durable lumber.

### Jungle Fort Tower Kit - Hardware

- (50) 3/8"x5" Hot Dipped Galv. Carriage Bolts
- (7) 3/8"x3" Hot Dipped Galv. Carriage Bolts
- (60) 3/8" HDG Washer, Lock Washer & Nuts
- (4) 2"x6" HDG Joist Hangers
- (2) 3" x 2" HDG Galv. Corner Braces
- (10) 3/8"x5"HDG Lag Screws
- (16) 3/8"x2 1/2"HDG Lag Screws
- (300) 2 1/2" HDG Drywall Decking Screws
- (50) HDG Joist Hanger Nails

Visit <http://detailedplay.com/JungleFortTower.htm>

### Tower Accessories

- 59" x 68" Vinyl Roof Top (1)
- Handgrips (1"-dia. x 10" / slide & ladder) (4)
- 14' straight Slide or Turbo Slide (84" platform)

# Jungle Swingset Slide - Materials Lists

(Standalone Swingset with optional Slide Platform addition,  
8'-9'-10' beam height, 12'L, 3 positions)

## Building Materials

### Treated Pine

#### (2) A-Frames (4x4)

Beam	4x4	Quantity
Height	length	
<b>8FT</b>	4x4x10'	(7)
<b>9FT</b>	4x4x12'	(4)
	4x4x10'	(3)
<b>10FT</b>	4x4x12'	(7)

#### Swing Beam (4x6)

4x6x12' (1)

**-or-**

2x6x12' (2)

#### Temporary Brace (2x4)

2x4x12' (1)

#### ADD for Slide Platform:

(+1 10ft 'A') 4x4x12' (3)

2x6x12' (2)

2x6x8' (1)

2x4x12' (4)

**Note:** Use of Treated Pine 4x6 is recommended for maximum strength swing beam.

## Hardware

### Swingset

7" x 1/2" Galv. Carriage Bolt	(16)
11" x 1/2" Galv. Carriage Bolt	(2)
1/2" Galv. Washer, Lock Washer, & Nut	(18)
5" x 3/8" Galv. Lag Screws	(16)
2 1/2" x 3/8" Galv. Lag Screws	(8)
3/8" Galv. Flat Washer	(24)
2 1/2" Galv. Drywall Decking Screws	(15)
6" Swing Hangers w/ Bolt, Washer, Lock Nut	(6)
(Optional: Ductile Iron or Composite Steel Hangers)	

### Slide Platform

7" x 1/2" Galv. Carriage Bolt	(8)
11" x 1/2" Galv. Carriage Bolt	(1)
1/2" Washer, Lock Washer, & Nut	(9)
5" x 3/8" Galv. Lag Screws	(18)
2 1/2" x 3/8" Galv. Lag Screws	(4)
3/8" Galv. Flat Washer	(22)
2 1/2" Galv. Drywall Decking Screws	(125)

### Tools

Miter Saw or Circular Saw with Carbide Blade  
Power Drill, Standard 1/4" 1/8" Wood Bits  
Wood Boring Spade/Paddle Bits: 9/16" & 1-1/2"  
Socket Wrench - 3/4" & 9/16" Deep Socket  
Pencil, Tape Measure, Level, Hammer, Safety Glasses/Mask,  
Cord, Sandpaper



# PRICE LIST & ORDER FORM

Mail or Fax this completed order form to Detailed Play Systems or call us toll free at **1-800-398-7565**

Or Order Online... Fast & Secure... [www.detailedplay.com](http://www.detailedplay.com)

**Visit our website for special offers on kits, slides and shipping!**

*Price List Effective: January 1, 2017 (Supercedes all others and is subject to change at anytime)*

## Playground Kits Detailed Plans included with Kit Purchase. *Just Add Lumber!*

		Price	Sub-Total
<b>Jungle Swingset / Jungle Swingset Slide</b> Everything needed to build standalone Swingset and optional slide Platform except standard sized lumber. Add on Bucket Swings, Buoy Ball Swing, Slide, customize all Swing Playground Accessories.	<b>Includes:</b> (1) Swingset Main Kit, (2) Belt Swings with Coated Chains, (1) Trapeze Rings with Coated Chains, (4) Metal Ground Anchors;	\$205.00	
	<b>with Slide Platform adds:</b> (1) Slide Platform Main Kit, (1) Slide Platform Roof Top, (2) Pair Safety Handgrips, (2) 8 1/2 ft Swing Chain Upgrade	\$250.00	
<b>Jungle Fort Swingset</b> Everything needed to build Fort + attached Swingset except standard sized lumber. Add on Slides, "Add-on Kits" and Accessory PAKs.	<b>Includes:</b> (1) Fort & Swingset Main Kit, (1) Fort Roof Tarp, (2) Belt Swings with Coated Chains, (1) Trapeze Rings with Coated Chains, (2) Pair Safety Handgrips	\$359.00	
<b>Jungle Fort</b> Everything needed to build Fort except standard sized lumber. Add on Slides, "Add-on Kits" and Accessory PAKs.	<b>Includes:</b> (1) Fort Main Kit, (1) Fort Roof Tarp, (1) Belt Swing with Coated Chains, (2) Pair Safety Handgrips	\$255.00	
<b>Jungle Fort Tower</b> Everything needed to build Fort + Tower except standard sized lumber. Add on Slides, "Add-on Kits" and Accessory PAKs.	<b>Includes:</b> (1) Fort Main Kit, (1) Tower Main Kit, (1) Fort Roof Tarp, (1) Tower Roof Tarp, (1) Belt Swing with Coated Chains, (4) Pair Safety Handgrips	\$474.00	
<b>Jungle Fort Campus</b> Everything needed to build a (2) Fort Campus. Add on Tube Tunnel, Slides, "Add-on Kits" and Accessories.	<b>Includes:</b> (2) Fort Main Kits, (2) Fort Roof Tarps, (4) Pair Safety Handgrips	\$436.00	
<b>Jungle Fort Swingset + Tower</b> Everything needed to build Fort + Swingset + Tower except standard sized lumber. Add on Slides, "Add-on Kits" and Accessories.	<b>Includes:</b> (1) Fort & Swingset Main Kit, (1) Tower Main Kit, (1) Fort Roof Tarp, (1) Tower Roof Tarp, (2) Belt Swings with Coated Chains, (1) Trapeze Bar with Coated Chains, (4) Pair Safety Handgrips	\$578.00	
<b>Jungle Fort Campus + Tower</b> Everything needed to build (2) Forts + Tower except standard sized lumber. Add on Tube Tunnel, Slides, "Add-on Kits" and Accessories.	<b>Includes:</b> (2) Fort Main Kits, (1) Tower Fort Kit, (2) Fort Roof Tarps, (1) Tower Roof Tarp, (6) Pair Safety Handgrips	\$655.00	
<b>Builder Fort / Builder Fort Swingset</b> Everything needed to build Fort or Fort + Swingset except standard sized lumber. Add on Slides, "Add-on Kits" and customize all accessories.	<b>Fort Includes:</b> (1) Fort Main Kit, (1) Fort Roof Top	\$204.00	
	<b>Fort Swingset Includes:</b> (1) Fort & Swingset Main Kit, (1) Fort Roof Top	\$239.00	

### Choose Color & Quantity of Each

	Blue	Green	Red	Yellow	BYB*	GYG*	RYR*	
<b>Fort Roof Tarp(s):</b>								<b>*Colors for Multi-Colored Fort &amp; Tower Roof Tarps:</b> BYB = Blue - Yellow - Blue GYG = Green - Yellow - Green RYR = Red - Yellow - Red Gray denotes color is unavailable.
<b>Belt Swing(s) with Coated Chains</b>								
<b>Trapeze with Rings Coated Chains</b>								
<b>Handgrips</b>								
<b>Tower Roof Tarp</b>								

### Add-on Kits *Great additions to your Detailed Play Playground Kit!*

<b>Jungle Fort Flags</b>	Complete with 5/8" hardwood dowel with 3/8" tenon for easy installation.							\$10.95 Solid	\$12.95 Multi-Color	
<b>Monkey Bar Kit</b>	Add Monkey Bars to the Jungle Fort. Includes plans, (10) select maple hardwood dowels and hardware.							\$95.00		
<b>Rock Wall Kit</b>	Add Rock Climbing Wall to Jungle Fort. Your choice: <input type="checkbox"/> 10 Sand (B G Y R) -OR- <input type="checkbox"/> 12 Plastic Holds (B G Y R)							\$55.00/\$65.00		
<b>Picnic Table Kit</b>	<b>Picnic Table Cover:</b> Choose (1)							\$49.00		
Galvanized hardware included.	Easy to add-on a picnic table to the Jungle Fort with marine grade vinyl picnic table cover.									
<b>Tire Swing Kit</b>	Swivel, Chains and bolts included.							\$95.00		
	Easy to add-on a tire swing to the Jungle Fort. Tire not included (purchase locally).									
<b>Swingset A-Frame Kit</b>	Add hardware to build a second A-Frame.							\$25.00		
<b>Swing Hanger Upgrade Kit</b>	Exchange: (6) Composite Steel Hangers -OR- (6) Ductile Iron Hangers (with Main kit Purchase ONLY)							\$50.00 Composite	\$65.00 Duc. Iron	
<b>Jungle Fort Mega Top</b>	Add a whopping 59"x160" sized Mega Top to the Jungle Fort!							\$139.95		

### Slides, Tunnels & Panels

		Choose Color & Quantity of Each										
		Blue	Green	Red	Yellow	BYB*	GYG*	RYR*				
<b>10' Wave Slide</b>	5' Fort Mount									\$3; 0.00		
<b>10' Combo Slide</b>	5' Fort Mount									\$747.00		
<b>10' Scoop Slide</b>	5' Fort Mount									\$497.00		
<b>Spiral Slide</b>	5' Fort Mount									\$490.00		
<b>14' Scoop Slide</b>	7' Tower Mount									\$937.00		
<b>14' Combo Slide</b>	7' Tower Mount									\$7; 5.00		
<b>Turbo Slide</b>	7' Tower Mount									\$695.00		
<b>Tube Tunnel</b>	60" Length									\$525.00		
<b>Jungle Bubble</b>	30" W x 36" H Lexan Bubble (Std. Delivery)									\$185.00		
<b>Mountain Climb</b>	Gray 66" Height	Gray								\$490.00		
<b>Decorative Slide Covers</b>	Decorative slide covers that fit 10 foot slides! Race Car, Soccer, and Sailboat Models Available.	Qty								\$95.00		
			Choose Design: <input type="checkbox"/> Race Car <input type="checkbox"/> Soccer <input type="checkbox"/> Sailboat									

### Save **10-15%** with Our Accessory PAKs!

		Choose Color					
		Blue	Green	Red	Yellow		
<b>Kit Accessory Pak 1</b> Contains (1) each of our popular Telescope, Telephone and Wheel. Specify color by putting (1) "X" in the boxes provided at right.	Telephone					\$46.00	
	Telescope						
	Wheel						
<b>Kit Accessory Pak 2</b> Contains (1) of the Disc Swing, Children's Glider and 36" Rope Ladder (no color choice).	Disc Swing					\$215.00	
	Children's Glider						
<b>Kit Accessory Pak 3</b> Contains (1) of Trapeze/Buoy Ball Combo, Children's Glider and Jungle Bubble Panel.	Trapeze/Buoy Ball					\$394.00	
	Children's Glider						
	Jungle Bubble Panel						
<b>Kit Accessory Pak 4</b> Contains (1) of 36" Rope Ladder (no color choice), Periscope and Disc Swing.	Periscope					\$115.00	
	Disc Swing						

# Playground Equipment

Great additions to your Detailed Play Playground Kit!

## Choose Color & Quantity of Each

—Continued—

	Choose Color & Quantity of Each							Price	Sub-Total
	Blue	Green	Red	Yellow	BYB	GYG	RYR		
<b>Belt Swing</b> Choose: <input type="checkbox"/> Roped <input type="checkbox"/> Coated <input type="checkbox"/> Soft Grip								\$35.95 Roped \$40.95 Coated \$51.95 Soft Grip	
<b>Half Bucket Swing</b> Choose: <input type="checkbox"/> Roped <input type="checkbox"/> Coated <input type="checkbox"/> Soft Grip								\$53.95 Roped \$58.95 Coated \$69.95 Soft Grip	
<b>Full Bucket Swing</b> Choose: <input type="checkbox"/> Roped <input type="checkbox"/> Coated <input type="checkbox"/> Soft Grip								\$63.95 Roped \$68.95 Coated \$79.95 Soft Grip	
<b>Commercial Toddler Swing</b> Plastisol Chains with spring-loaded connectors								\$119.95 Coated \$129.95 Soft Grip	
<b>Toddler High Back Swing</b> Rope & chains with spring-loaded connectors.								\$38.50	
<b>Children's Glider</b> Requires 4pt. Mounting. Some assembly required.								\$129.95	
<b>Buoy Ball Swing</b> Buoy Ball & Trapeze.								\$84.95	
<b>Commercial Flat Swing</b> Plastisol chains with spring loaded connectors.								\$73.95 Coated \$83.95 Soft Grip	
<b>Disc Swing</b> Includes 1/2" Nylon Rope.								\$22.95	
<b>Spring Disc</b> Tough coil spring inside PVC tube. Tested to 600 lbs.								\$104.95	
<b>Winston Cup Tire</b> Actually used NASCAR tire! Tire only.	Black							\$95.00	
<b>Plastic Tire</b> Tough rotomolded commercial grade design. Tire only.								\$125.00	
<b>Trapeze Bar with Rings</b> Powder-coated metal bar and coated chain.								\$39.95	
<b>Trapeze Buoy Combo</b> Includes (2) spring-loaded connectors.								\$119.95	
<b>Soft Punching Bag</b> Made from foam-filled marine grade vinyl.								\$95.00	
<b>Cubby Bear Swing</b> A Child-friendly Swing Design! (Available in Brown only)	Brown							\$38.50	
<b>Swing Hangers</b> Galvanized, 3/8" bolt, nylon bushing. Choose: <input type="checkbox"/> 4" <input type="checkbox"/> 6"	Qty							\$9.95 pair	
<b>Composite Beam Hangers</b> Steel/Plastic Composite Hangers.	Qty							\$19.95 pair	
<b>Ductile Iron Hangers</b> Iron Hangers	Qty							\$24.95 pair	
<b>Tire Swing Swivel</b> For light duty residential use.	Qty							\$24.95	
<b>Heavy-Duty Tire Swing Swivel</b> For heavy duty residential use.	Qty							\$49.95	
<b>Tire Eye Bolts</b> Set of (3), includes washers and nylon insert lock nuts.	Qty							\$22.50	
<b>Plastisol Swing Chain</b> Choose: <input type="checkbox"/> 5-1/2ft. <input type="checkbox"/> 8-1/2ft. (Yellow Only)								\$15.85 5-1/2ft. \$21.50 8-1/2ft.	
<b>Soft Grip Swing Chain</b> 5ft. Length.								\$20.95	
<b>Spring Loaded Clips</b> Attach swing chain to swing hangers.	Qty							\$1.75 each	
<b>Rope Ladder</b> Choose: <input type="checkbox"/> 18" <input type="checkbox"/> 24" <input type="checkbox"/> 36"								\$48.95 18" \$58.95 24" \$84.95 36"	
<b>Sand Rock Holds</b> Set of (10). Hardware not included.								\$55.00	
<b>Plastic Rock Holds</b> Set of (12). Hardware not included.								\$65.00	
<b>Plastic Rock Panels</b> Set of (8). Hardware not included.								\$55.00	
<b>Jungle Fort Roof Tarp</b> Includes hold-down snap installation hardware								\$94.95 Reg./Multi Custom Available*	*Calculate Online
<b>Sandbox Cover</b> For Jungle Fort. With hold-down snap installation hardware.								\$94.95 Regular Custom Available*	*Calculate Online
<b>Fun Ride Deluxe</b> 70' Cable with all parts and hardware.	Qty							\$104.95	
<b>Twizzler</b> 9' rope included with spinner bar.								\$39.95	
<b>Non-Skid Strips</b> Set of (5). Self-adhesive.	Qty							\$12.95	
<b>Bumper Pads</b> Made from foam filled marine grade vinyl.								\$44.00	
<b>Steering Wheel</b> 12" diameter, plastic with mounting hardware.								\$17.95	
<b>Telescope</b> 12" length, plastic with clear lenses and mounting hardware.								\$18.95	
<b>Periscope</b> Polyethylene with clear plastic lenses and mirror. 15-1/2", detaches.								\$19.95	
<b>Telephone</b> 8-3/8" length, molded plastic.								\$16.95	
<b>Handgrips (Pair)</b> 10" length, plastic with finger ridges and mounting hardware.								\$9.95	
<b>Talk Tube Horns</b> Pair of molded plastic talk tube horns.								\$32.50	
<b>Talk Tube Hose</b> Corrugated plastic hose and fasteners (Sold by the foot).								\$1.55/ft.	

## Calculate Shipping & Handling

Order Type	Method	Delivery	SUB-TOTAL
Detailed Plans Only	First Class Mail	2-5 Days	Calculate items ordered to achieve Subtotal.
Playground Kits (1st Shipment)	UPS Ground	2-5 Days	<b>SHIPPING</b> (Use table below to calculate base shipping)
Playground Kits (2nd Shipment)	UPS/Freight	7-14 Days	SUBTOTAL: \$0 - \$60.00: <b>\$16.95 *</b> \$201.00 - \$300.00: <b>\$ *</b>
			\$61.00 - \$100.00: <b>\$24.95 *</b> \$301.00 - \$400.00: <b>\$ *</b>
			\$101.00 - \$199.00: <b>\$34.95 *</b> \$401.00 - \$600.00: <b>\$ *</b>
			* Visit <a href="http://detailedplay.com">detailedplay.com</a> for our latest Shipping Specials!
			<b>LESS: CREDIT</b> (Subtract a previous Detailed Plan purchase - \$ _____) <b>GRAND TOTAL:</b>

## Your Shipping Address

Please Complete the Following.

NAME	
ADDRESS	
CITY • STATE • ZIP	
PHONE (Required):	E-MAIL ADDRESS:

## Payment Information

Please Complete the Following.

PAYMENT BY (Check One):	
<input type="checkbox"/> CHECK	<input type="checkbox"/> VISA <input type="checkbox"/> MasterCard <input type="checkbox"/> AMERICAN EXPRESS <input type="checkbox"/> DISCOVER
CARDHOLDER NAME:	
CARD NUMBER:	
CUSTOMER SIGNATURE:	
EXPIRATION DATE:	PHONE NUMBER (if different from Shipping Address):
BILLING ADDRESS (if different from Shipping Address):	

## Terms & Conditions of Sale

- Motor:** Customer authorizes DPS to hire freight company on customer's behalf when order contains any slide or playground mulch.
- Freight:** Sale is F.O.B. (Freight on Board). Title to goods transfers to customer when loaded onto truck at seller's facilities. For curbside unload, customer must inspect and document condition of goods on freight slip/Bill of Lading at time of delivery.
- Application:** These products are intended for use in a residential playground setting.
- License:** Purchase of Detailed Plans herein grants customer a single license for personal, non-business use. Contact DPS for resale installation.
- Liability:** Detailed Play Systems shall not be liable for incidental, indirect, special or consequential damages incurred from the build or use of the plans or products herein. In no event will Detailed Play Systems be liable for damages beyond the invoiced price.
- Warranty:** Our products are warranted against defects in material and workmanship resulting from normal use for a period of one year from date of delivery. All other warranties, expressed or implied, are hereby excluded.
- Returns:** Contact Detailed Play Systems within 30 days of delivery to request a Return Merchandise Authorization (RMA) for a full refund. Refunds will exclude the costs and expenses incurred by Detailed Play Systems for shipping and handling.
- I understand and agree to these TERMS & CONDITIONS OF SALE:



Signed \_\_\_\_\_

Date: \_\_\_\_\_

Mail or Fax this completed order form to Detailed Play Systems or call us toll free at 1-800-398-7565 Or Order Online... Fast & Secure...



[www.detailedplay.com](http://www.detailedplay.com)

P.O. Box 638 • Manahawkin, NJ 08050 • email: [playsets@detailedplay.com](mailto:playsets@detailedplay.com)  
Phone: 800-398-7565 • Fax: 973-710-3087